



TRIGO S

Silla manual activa plegable
con reposapiés fijos
multi-ajustable
con gran rango de opciones



	P.V.P.
S = Standard O = opción sin coste extra □ = opción con coste extra	1.900,00 €

ESTRUCTURA				
Ancho de asiento (asiento ajustable en tensión)				
	Chasis cerrado 70° (ángulo del reposapiés)	<input type="radio"/>	-	
	Chasis cerrado 80° (ángulo del reposapiés) <i>incompatible con rueda delantera de 6"</i>	<input type="radio"/>	-	
	Chasis cerrado 90° (ángulo del reposapiés) <i>incompatible con rueda delantera de 6" o ancho de asiento de ≤ 38cm</i>	<input type="radio"/>	-	

ASIENTO													
Ancho (cm)	Profundidad (cm)												
	32	34	36	38	40	42	44	46	48	50			
30	<input type="radio"/>	<input type="radio"/>	<input type="radio"/>	<input type="radio"/>	<input type="radio"/>	<input type="radio"/>	<input type="radio"/>	<input type="radio"/>	<input type="radio"/>	<input type="radio"/>	<input type="radio"/>	-	Cruceta simple peso máx. usuario: 70 kg
32	<input type="radio"/>	<input type="radio"/>	<input type="radio"/>	<input type="radio"/>	<input type="radio"/>	<input type="radio"/>	<input type="radio"/>	<input type="radio"/>	<input type="radio"/>	<input type="radio"/>	<input type="radio"/>	-	
34	<input type="radio"/>	<input type="radio"/>	<input type="radio"/>	<input type="radio"/>	<input type="radio"/>	<input type="radio"/>	<input type="radio"/>	<input type="radio"/>	<input type="radio"/>	<input type="radio"/>	<input type="radio"/>	-	
36	-	-	<input type="radio"/>	<input type="radio"/>	<input type="radio"/>	<input type="radio"/>	<input type="radio"/>	<input type="radio"/>	<input type="radio"/>	<input type="radio"/>	<input type="radio"/>	-	
38	-	-	<input type="radio"/>	<input type="radio"/>	<input type="radio"/>	<input type="radio"/>	<input type="radio"/>	<input type="radio"/>	<input type="radio"/>	<input type="radio"/>	<input type="radio"/>	-	Cruceta 1,5 peso máx. usuario: 130 kg
40	-	-	<input type="radio"/>	<input type="radio"/>	<input type="radio"/>	<input type="radio"/>	<input type="radio"/>	<input type="radio"/>	<input type="radio"/>	<input type="radio"/>	<input type="radio"/>	-	
42	-	-	<input type="radio"/>	<input type="radio"/>	<input type="radio"/>	<input type="radio"/>	<input type="radio"/>	<input type="radio"/>	<input type="radio"/>	<input type="radio"/>	<input type="radio"/>	-	
44	-	-	<input type="radio"/>	<input type="radio"/>	<input type="radio"/>	<input type="radio"/>	<input type="radio"/>	<input type="radio"/>	<input type="radio"/>	<input type="radio"/>	<input type="radio"/>	-	
46	-	-	<input type="radio"/>	<input type="radio"/>	<input type="radio"/>	<input type="radio"/>	<input type="radio"/>	<input type="radio"/>	<input type="radio"/>	<input type="radio"/>	<input type="radio"/>	-	Doble cruceta peso máx. usuario: 130 kg
48	-	-	<input type="radio"/>	<input type="radio"/>	<input type="radio"/>	<input type="radio"/>	<input type="radio"/>	<input type="radio"/>	<input type="radio"/>	<input type="radio"/>	<input type="radio"/>	-	
50	-	-	<input type="radio"/>	<input type="radio"/>	<input type="radio"/>	<input type="radio"/>	<input type="radio"/>	<input type="radio"/>	<input type="radio"/>	<input type="radio"/>	<input type="radio"/>	-	
<i>mínimo ancho total con protectores estándar y 0° caída: Ancho asiento + 16 cm</i>													

ALTURA DELANTERA ASIENTO (en mm)													
	390	400	410	420	430	440	450	460	470	480	490	500	510
rueda 3"	<input type="radio"/>	<input type="radio"/>	<input type="radio"/>	<input type="radio"/>	<input type="radio"/>	<input type="radio"/>	<input type="radio"/>	<input type="radio"/>	<input type="radio"/>	<input type="radio"/>	<input type="radio"/>	<input type="radio"/>	<input type="radio"/>
rueda 4"	<input type="radio"/>	<input type="radio"/>	<input type="radio"/>	<input type="radio"/>	<input type="radio"/>	<input type="radio"/>	<input type="radio"/>	<input type="radio"/>	<input type="radio"/>	<input type="radio"/>	<input type="radio"/>	<input type="radio"/>	<input type="radio"/>
rueda 5"	<input type="radio"/>	<input type="radio"/>	<input type="radio"/>	<input type="radio"/>	<input type="radio"/>	<input type="radio"/>	<input type="radio"/>	<input type="radio"/>	<input type="radio"/>	<input type="radio"/>	<input type="radio"/>	<input type="radio"/>	<input type="radio"/>
rueda 6"	<input type="radio"/>	<input type="radio"/>	<input type="radio"/>	<input type="radio"/>	<input type="radio"/>	<input type="radio"/>	<input type="radio"/>	<input type="radio"/>	<input type="radio"/>	<input type="radio"/>	<input type="radio"/>	<input type="radio"/>	<input type="radio"/>

ALTURA TRASERA ASIENTO (en mm)																				
	325	335	345	355	365	375	385	395	405	415	425	435	445	455	465	475	485	495	505	515
rueda 18"	<input type="radio"/>	<input type="radio"/>	<input type="radio"/>	<input type="radio"/>	<input type="radio"/>	<input type="radio"/>	<input type="radio"/>	<input type="radio"/>	<input type="radio"/>	<input type="radio"/>	<input type="radio"/>	<input type="radio"/>	<input type="radio"/>	<input type="radio"/>	<input type="radio"/>	<input type="radio"/>	<input type="radio"/>	<input type="radio"/>	<input type="radio"/>	<input type="radio"/>
rueda 20"	<input type="radio"/>	<input type="radio"/>	<input type="radio"/>	<input type="radio"/>	<input type="radio"/>	<input type="radio"/>	<input type="radio"/>	<input type="radio"/>	<input type="radio"/>	<input type="radio"/>	<input type="radio"/>	<input type="radio"/>	<input type="radio"/>	<input type="radio"/>	<input type="radio"/>	<input type="radio"/>	<input type="radio"/>	<input type="radio"/>	<input type="radio"/>	<input type="radio"/>
rueda 22"	<input type="radio"/>	<input type="radio"/>	<input type="radio"/>	<input type="radio"/>	<input type="radio"/>	<input type="radio"/>	<input type="radio"/>	<input type="radio"/>	<input type="radio"/>	<input type="radio"/>	<input type="radio"/>	<input type="radio"/>	<input type="radio"/>	<input type="radio"/>	<input type="radio"/>	<input type="radio"/>	<input type="radio"/>	<input type="radio"/>	<input type="radio"/>	<input type="radio"/>
rueda 24"	<input type="radio"/>	<input type="radio"/>	<input type="radio"/>	<input type="radio"/>	<input type="radio"/>	<input type="radio"/>	<input type="radio"/>	<input type="radio"/>	<input type="radio"/>	<input type="radio"/>	<input type="radio"/>	<input type="radio"/>	<input type="radio"/>	<input type="radio"/>	<input type="radio"/>	<input type="radio"/>	<input type="radio"/>	<input type="radio"/>	<input type="radio"/>	<input type="radio"/>
rueda 26"	<input type="radio"/>	<input type="radio"/>	<input type="radio"/>	<input type="radio"/>	<input type="radio"/>	<input type="radio"/>	<input type="radio"/>	<input type="radio"/>	<input type="radio"/>	<input type="radio"/>	<input type="radio"/>	<input type="radio"/>	<input type="radio"/>	<input type="radio"/>	<input type="radio"/>	<input type="radio"/>	<input type="radio"/>	<input type="radio"/>	<input type="radio"/>	<input type="radio"/>

Respete las siguientes diferencias máximas recomendadas entre la altura del asiento delantero y la altura del asiento trasero:

- * Para profundidad de asiento 32 cm - 36 cm: diferencia máxima de 4 cm
- * Para profundidad de asiento 36 cm - 44 cm: diferencia máxima de 7 cm
- * Para profundidad de asiento 44 cm - 50 cm: diferencia máxima de 10

Recuerde que la altura de asiento delantera *nunca* debe ser inferior a la altura de asiento trasera. Piense en la seguridad del usuario/a





TABLA EXPLICATIVA RUEDA DELANTERA - RUEDA TRASERA VS. PROFUNDIDADES DE ASIENTO

RUEDA DELANTERA	RUEDA TRASERA				
	18"	20"	22"	24"	26"
3"	profundidades de asiento posibles 32 - 50	profundidades de asiento posibles 32 - 50	profundidades de asiento posibles 36 - 50	profundidades de asiento posibles 38 - 50	profundidades de asiento posibles 44 - 50
4"	profundidades de asiento posibles 32 - 50	profundidades de asiento posibles 32 - 50	profundidades de asiento posibles 36 - 50	profundidades de asiento posibles 38 - 50	profundidades de asiento posibles 44 - 50
5"	profundidades de asiento posibles 32 - 50	profundidades de asiento posibles 32 - 50	profundidades de asiento posibles 36 - 50	profundidades de asiento posibles 38 - 50	profundidades de asiento posibles 44 - 50
6"	profundidades de asiento posibles 38 - 50	profundidades de asiento posibles 38 - 50	profundidades de asiento posibles 40 - 50	profundidades de asiento posibles 40 - 50	profundidades de asiento posibles 44 - 50

PROTECTORES

B82S fijo	Protector de ropa fijo - aluminio	○	-	img 001
B82-C fijo	Protector de ropa fijo - carbono	□	380,00 €	img 001
B82 fijo	Protector de ropa antisalpicaduras fijo - aluminio	□	54,00 €	img 002
Bi5	Reposabrazos ajustable en altura - modelo largo 33 cm	□	75,00 €	img 003
Bi5S	Reposabrazos ajustable en altura - modelo corto 20 cm	□	100,00 €	
TUBE	Reposabrazos tubular (abatible) 23" incompatible con respaldo regulable o	□	100,00 €	img 004
TUBE LONG	Reposabrazos tubular (abatible) 28" incompatible con respaldo regulable o	□	130,00 €	
B82S-C	Protector de ropa extraíble - carbono	□	340,00 €	img 005
B82SL-A	Protector de ropa extraíble LARGO - aluminio	□	105,00 €	img 006
B82L-A	Protector de ropa antisalpicaduras extraíble LARGO - aluminio	□	135,00 €	img 007
B82-C	Protector de ropa antisalpicaduras extraíble - carbono	□	380,00 €	img 008



img 001



img 002

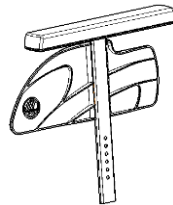

img 003

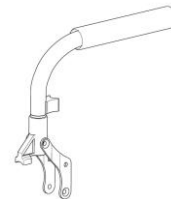

img 004



img 005

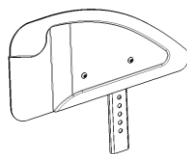

img 006



img 007

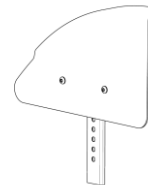

img 008

REPOSAPIÉS				
Monoblock de aluminio, plegable	<input type="radio"/>	-		img 011
Moloblock de aluminio, elevado	<input type="checkbox"/>	105,00 €		img 012
Monoblock de carbono	<input type="checkbox"/>	315,00 €		img 013
Invertido (para extremidades más cortas)	<input type="checkbox"/>	195,00 €		img 014
Invertido en carbono (para extremidades más cortas) - plegable y angulo ajustable de la p	<input type="checkbox"/>	405,00 €		img 014
Monoblock abatible	<input type="checkbox"/>	50,00 €		img 015
Paletas reposapiés independientes <i>(solo posible con longitud de pierna (LLL) de 37 a</i>	<input type="checkbox"/>	50,00 €		img 016

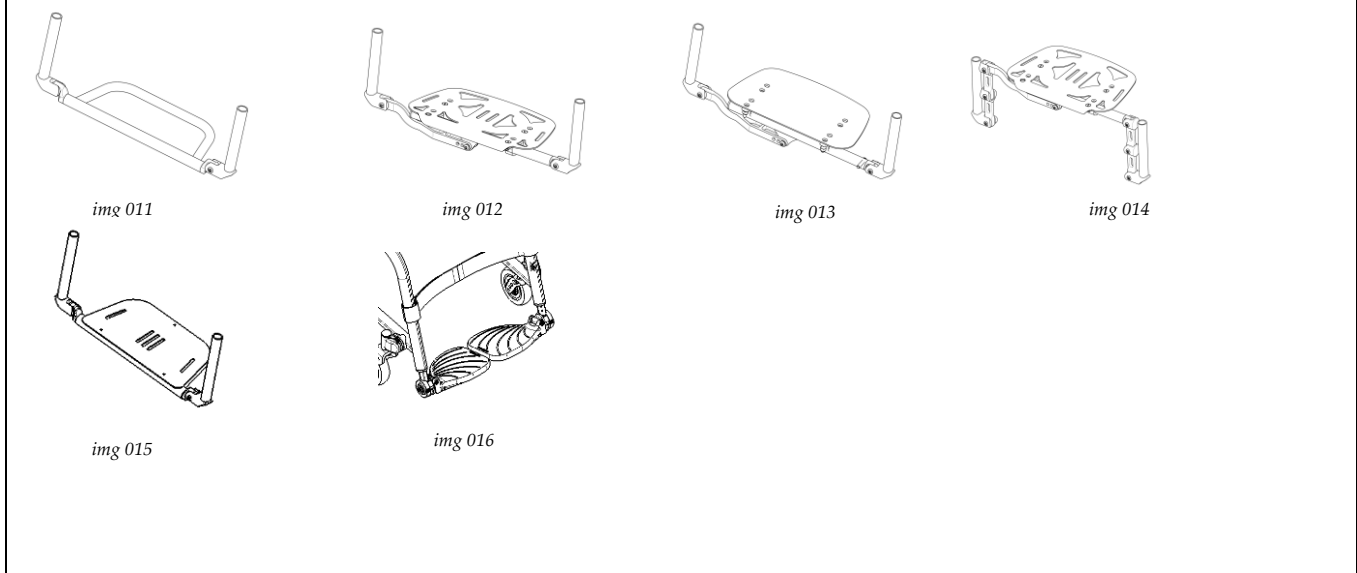



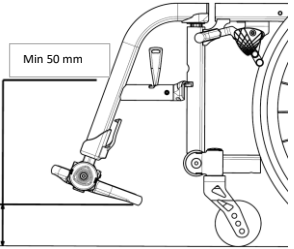

Longitud de pierna (LLL)	distancia entre hueso poplíteo y arco plantar		
22 cm	<i>solo posible con pedd invertido</i>		<input type="radio"/>
23 cm	<i>solo posible con pedd invertido</i>		<input type="radio"/>
24 cm	<i>solo posible con pedd invertido</i>		<input type="radio"/>
25 cm	<i>solo posible con pedd invertido</i>		<input type="radio"/>
26 cm	<i>solo posible con pedd invertido</i>		<input type="radio"/>
27 cm	<i>solo posible con pedd invertido</i>		<input type="radio"/>
28 cm	<i>solo posible con pedd invertido</i>		<input type="radio"/>
29 cm	<i>solo posible con pedd invertido</i>		<input type="radio"/>
30 cm	<i>solo posible con pedd invertido</i>		<input type="radio"/>
31 cm	<i>solo posible con pedd invertido</i>		<input type="radio"/>
32 cm	<i>solo posible con pedd invertido</i>		<input type="radio"/>
33 cm	<i>solo posible con pedd invertido</i>		<input type="radio"/>
34 cm	<i>solo posible con pedd invertido</i>		<input type="radio"/>
35 cm			<input type="radio"/>
36 cm			<input type="radio"/>
37 cm			<input type="radio"/>
38 cm			<input type="radio"/>
39 cm			<input type="radio"/>
40 cm			<input type="radio"/>
41 cm			<input type="radio"/>
42 cm			<input type="radio"/>
43 cm			<input type="radio"/>
44 cm			<input type="radio"/>
46 cm			<input type="radio"/>

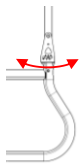
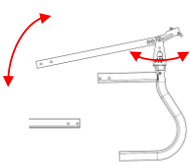

La longitud de pierna debe ser al menos 5cm menos que la altura delantera de asiento escogida

COLORES (chasis)					
Parte delantera		mate		brillo	
C4	Rojo	<input type="radio"/>	<input type="radio"/>	-	
C5	Negro	<input type="radio"/>	<input type="radio"/>	-	
C8	Amarillo	<input type="radio"/>	<input type="radio"/>	-	
C29	Plateado	<input type="radio"/>	<input type="radio"/>	-	
C53	Naranja	<input type="radio"/>	<input type="radio"/>	-	
C55	Inox	<input type="radio"/>	<input type="radio"/>	-	
C56	Azul metálico	<input type="radio"/>	<input type="radio"/>	-	
C59	Champagne	<input type="radio"/>	<input type="radio"/>	-	
C71	Azul abisal metálico	-	<input type="radio"/>	-	
C72	Rojo cereza metálico	-	<input type="radio"/>	-	
C73	Verde metálico	-	<input type="radio"/>	-	
C76	Blanco	<input type="radio"/>	<input type="radio"/>	-	
C78	Azul petróleo	-	<input type="radio"/>	-	
C79	Azul celeste	<input type="radio"/>	<input type="radio"/>	-	
C85	Verde brillante	<input type="radio"/>	<input type="radio"/>	-	
C87	Calabaza	<input type="radio"/>	<input type="radio"/>	-	
C88	Oro	<input type="radio"/>	<input type="radio"/>	-	
C89	Cobre	<input type="radio"/>	<input type="radio"/>	-	
	Color personalizado	<input type="checkbox"/>	<input type="checkbox"/>	225,00 €	
Parte trasera					
	Negro mate	S		-	
	Color personalizado	<input type="checkbox"/>		225,00 €	

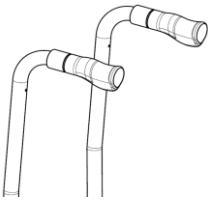
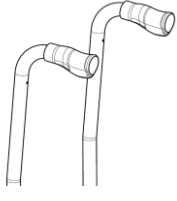

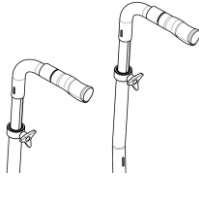
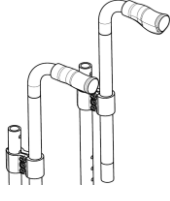
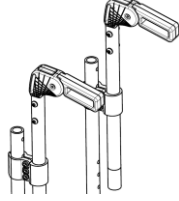
RESPALDO													
Estructura													
	Respaldo fijo	<input type="radio"/>	-								img 021		
	Respaldo reclinable (82° - 102°) ajuste mediante botón, ángulo standard: 90°	<input type="checkbox"/>	210,00 €								img 022		
	Respaldo reclinable & plegable (82° - 102°) ajuste mediante botón, ángulo standard: 90°	<input type="checkbox"/>	252,00 €								img 023		
													
		img 021		img 022		img 023							
Tapizado													
	Nylon - ajustable en tensión con reflectantes traseros	<input type="radio"/>	-										
	Cordura - ajustable en tensión con reflectantes traseros	<input type="radio"/>	-										
	Airflow - ajustable en tensión con reflectantes traseros	<input type="radio"/>	-										
	Bolsillo trasero	<input type="checkbox"/>	30,00 €										
													
Altura respaldo													
	Tipo de Puños de empuje (ver abajo)	no PH	PH 01	PH 02	PH 03	PH 04	PH 05	PH 06		<ul style="list-style-type: none"> • : compatible Δ : compatible sólo con respaldo fijo - : incompatible 			
Altura fija	25 cm	Δ	Δ	Δ	Δ	-	Δ	Δ	<input type="radio"/>	-			
	27 cm	Δ	Δ	Δ	Δ	-	Δ	Δ	<input type="radio"/>	-			
	29 cm	Δ	Δ	Δ	Δ	-	Δ	Δ	<input type="radio"/>	-			
	31 cm	Δ	Δ	Δ	Δ	-	Δ	Δ	<input type="radio"/>	-			
	33 cm	Δ	Δ	Δ	Δ	-	Δ	Δ	<input type="radio"/>	-			
	35 cm	•	•	•	•	-	•	•	<input type="radio"/>	-			
	37 cm	•	•	•	•	-	•	•	<input type="radio"/>	-			
	39 cm	•	•	•	•	Δ	•	•	<input type="radio"/>	-			
	41 cm	•	•	•	•	Δ	•	•	<input type="radio"/>	-			
	43 cm	•	•	•	•	Δ	•	•	<input type="radio"/>	-			
Ajustable en altura (3 tramos)	25 - 27,5 - 30 cm	Δ	Δ	Δ	-	-	-	-	<input type="checkbox"/>	30,00 €			
	30 - 32,5 - 35 cm	Δ	•	•	Δ	-	-	-	<input type="checkbox"/>	30,00 €			
	35 - 37,5 - 40 cm	•	•	•	•	-	-	-	<input type="checkbox"/>	30,00 €			
	40 - 42,5 - 45 cm	•	•	•	•	-	-	-	<input type="checkbox"/>	30,00 €			
	45 - 47,5 - 50 cm	•	•	•	•	-	-	-	<input type="checkbox"/>	30,00 €			
			•	•	•	•	-	-	-	<input type="checkbox"/>	30,00 €		
Puños de empuje													
no PH	Sin puños de empuje	<input type="radio"/>	-								no PH		
PH 01	Puños fijos (12cm)	<input type="checkbox"/>	15,00 €								PH 01		
PH 02	Puños fijos cortos (8cm)	<input type="checkbox"/>	15,00 €								PH 02		
PH 03	Puños plegables	<input type="checkbox"/>	150,00 €								PH 03		
PH 04	Ajustables en altura telescópicos	<input type="checkbox"/>	45,00 €								PH 04		
PH 05	Ajustables en altura con brida	<input type="checkbox"/>	150,00 €								PH 05		
PH 06	Ajustables en altura con brida y plegables	<input type="checkbox"/>	240,00 €								PH 06		
													
		PH 01		PH 02		PH 03		PH 04		PH 05		PH 06	



ASIENTO						
	Nylon lona fija	<i>cojín no incluido</i>		S	-	cojín no incluido
	Nylon ajustable en tensión	<i>cojín no incluido</i>		○	-	cojín no incluido
	Cojín de espuma 5 cm			□	60,00 €	
	Cojín de 5cm con capa viscolástica			□	120,00 €	
B24D	Cojín de 6 cm partido para plegado			□		

Cojines VICAIR						
	Cojín VICAIR ADJUSTER O2 6 cm			□	535,00 €	
	Cojín VICAIR ADJUSTER O2 10 cm			□	535,00 €	
	Cojín VICAIR VECTOR O2 6 cm			□	599,00 €	
	Cojín VICAIR VECTOR O2 10 cm			□	599,00 €	
	Cojín VICAIR ACTIVE O2 6 cm			□	575,00 €	
	Cojín VICAIR ACTIVE O2 10 cm			□	575,00 €	



ADJUSTER O2



VECTOR O2

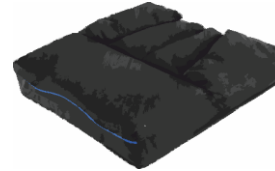

ACTIVE O2

RUEDAS							
Ruedas delanteras							
diámetro	3"	4"	5"	6"	SELECCIONAR MISMO DIÁMETRO QUE EL ESCOGIDO PARA LA ALTURA DE ASIENTO DELANTERA		
standard negro	○	○	○	○	6" es incompatible con chasis 80° y 90°		-
transparente	○	○	○				-
alu - plata	□	□	□				60,00 €
alu - rojo	□	□	□				60,00 €
alu - azul	□	□	□				60,00 €
carbono		□	□				105,00 €
LED		□	□				60,00 €



img 031



img 032



img 033



img 034



img 035

Ruedas traseras					
18"	Estándar, rueda 18" con cubiertas Schwalbe Marathon Racer	<input type="checkbox"/>	210,00 €	img 041 + img 048	
20"	De diseño, rueda ligera 20" , radial, cubiertas Schwalbe Right Run negras	<input type="radio"/>	-	img 042 + img 046	
22"	De diseño, rueda ligera 22" , radial, cubiertas Schwalbe Right Run negras	<input type="radio"/>	-	img 042 + img 046	
24" <i>(ancho de asiento mínimo requerido: 38cm)</i>	Rueda 24" full PU, radial con llanta negra (anti-pinchazos)				
	De diseño, rueda ligera 24" , radial, cubiertas Schwalbe Right Run negras	<input type="radio"/>	-	img 042 + img 046	
	De diseño, rueda ligera 24" , radial, cubiertas Schwalbe Marathon Plus	<input type="checkbox"/>	120,00 €	img 042 + img 047	
	Spirit 24" con buje de aluminio, radial, cubiertas Schwalbe Right Run negras	<input type="checkbox"/>	600,00 €	img 043 + img 046	
	Spirit 24" con buje de aluminio, radial, cubiertas Schwalbe Marathon Plus	<input type="checkbox"/>	650,00 €	img 043 + img 047	
	Spirit 24" buje rojo de aluminio, radial, cubiertas Schwalbe Right Run negras	<input type="checkbox"/>	600,00 €	img 043 + img 046	
	Spirit 24" buje rojo de aluminio, radial, cubiertas Schwalbe Marathon Plus	<input type="checkbox"/>	650,00 €	img 043 + img 047	
	Spirit 24" buje azul de aluminio, radial, cubiertas Schwalbe Right Run negras	<input type="checkbox"/>	600,00 €	img 043 + img 046	
	Spirit 24" buje azul de aluminio, radial, cubiertas Schwalbe Marathon Plus	<input type="checkbox"/>	650,00 €	img 043 + img 047	
	Spinergy 24" wheel , tire: Schwalbe Marathon Plus	<input type="checkbox"/>	1.600,00 €		
26"	De diseño, rueda ligera 26" , radial, cubiertas Schwalbe Right Run negras	<input type="checkbox"/>	75,00 €	img 042 + img 046	
	De diseño, rueda ligera 26" , radial, cubiertas Schwalbe Marathon Plus	<input type="checkbox"/>	180,00 €	img 042 + img 046	
	Off road 24" (juego extra de ruedas)	<input type="checkbox"/>	500,00 €	img 044	
HEM2	Kit doble aro - rueda 24 x 1 3/8"	<input type="checkbox"/>	350,00 €	<input type="checkbox"/> IZQ <input type="checkbox"/> DCHA	



img 046:
Right Run



img 047:
Marathon Plus



img 048:
Marathon Racer



img 041



img 042



img 043



img 044

Caída (modificable por el usuario)

0°		<input type="radio"/>	-	
2°		<input type="radio"/>	-	
4°		<input type="radio"/>	-	
6°		<input type="radio"/>	-	

Frenos

	Freno de tiro (bloqueo tirando hacia atrás)	<input type="radio"/>	-	img F01
	Freno de empuje (bloqueo empujando hacia adelante)	<input type="radio"/>	-	img F02
	Freno deportivo <i>(la profundidad de asiento debe ser ≥ 42cm)</i>	<input type="checkbox"/>	75,00 €	img F03
B74	Frenos de tambor (sólo camber 0°)-ruedas 24 x 1 3/8" macizas negras	<input type="checkbox"/>	160,00 €	img F04
	<i>no compatible con empuñaduras plegables o silla sin empuñaduras</i>	<input type="checkbox"/>	160,00 €	img F04
B40	Extensión de palanca de freno <i>(siempre necesario para kit HEM2)</i>	<input type="checkbox"/>	30,00 €	img F05

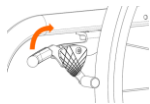

img F01



img F02



img F03



img F04



img F05



OPCIONES					
B31L	Porta-bastones izquierdo		<input type="checkbox"/>	30,00 €	img 051
B31R	Porta-bastones derecho		<input type="checkbox"/>	30,00 €	img 051
B78R	Rueda anti-vuelco derecha	<i>incompatible con ruedas tránsito altura trasera mínima requerida 37,5 cm</i>	<input type="checkbox"/>	60,00 €	img 052
B78L	Rueda anti-vuelco izquierda		<input type="checkbox"/>	60,00 €	img 052
B86	Ruedas tránsito	<i>incompatible con anti-vuelco</i>	<input type="checkbox"/>	120,00 €	img 053
B90	Barra estabilizadora respaldo	<i>no compatible con PH 00/01/02/03/06</i>	<input type="checkbox"/>	30,00 €	img 054
L04 L	Control lateral IZQUIERDO		<input type="checkbox"/>	350,00 €	img 055
L04S L	Control lateral IZQUIERDO - PEQUEÑO	<i>incompatibles con respaldo ajustable en altura o respaldo plegable</i>	<input type="checkbox"/>	285,00 €	img 056
L04 R	Control lateral DERECHO		<input type="checkbox"/>	350,00 €	img 055
L04S R	Control lateral DERECHO - PEQUEÑO		<input type="checkbox"/>	285,00 €	img 056
B58	Cinturón con hebilla metálica sistema quick		<input type="checkbox"/>	63,00 €	
B33	Cubre-aros de gel		<input type="checkbox"/>	120,00 €	img 057
B330	Aro con recubrimiento blando	<i>incompatibles con Kit Hem2</i>	<input type="checkbox"/>	150,00 €	
B330A	Aro con recubrimiento blando - Advanced grip	<i>incompatibles con Kit Hem2</i>	<input type="checkbox"/>	150,00 €	
B85 transparent	Cubre-radios		<input type="checkbox"/>	90,00 €	img 058
B85 M5	Cubre-radios - PLANETA AZUL		<input type="checkbox"/>	160,00 €	img 059
B85 M6	Cubre-radios - JUNGLA		<input type="checkbox"/>	160,00 €	img 060
B85 M7	Cubre-radios - TRIGO 1		<input type="checkbox"/>	160,00 €	img 061
B85 M8	Cubre-radios - TRIGO 2		<input type="checkbox"/>	160,00 €	img 062
V10	Cubretubo/protector Neopreno Gelpad		<input type="checkbox"/>	75,00 €	img 063

